

INTRODUCTION

WHAT IS MP3/WMA FORMAT?

MP3 /WMA format files are compressed digital audio files, which consumers can listen to with near CD quality

Commercial CD audio files can be compressed to MP3 / WMA format files, which are suitable for internet transmission due to their compact size and can be stored in a portable audio device. The users, for example, can record their own favorite music album, storing it in on board flash or memory card in a digital audio player.

WHAT IS THIS AUDIO PLAYER?

This digital audio player is a portable and lightweight device, which can be used for MP3 / WMA music files playback and ADPCM (WAV) files record/playback, and it additionally can be used as a drive while connected to PC.

You can enjoy CD quality music without the inconvenience of having to carry around a heavy CD player. The digital music files accessed by this player are stored in on board flash or memory card. This means that the player has no moving parts, so the music will never jump or skip when playing.

Furthermore, it can be recognized as portable removable drives when connected to PC or notebook by the USB interface cable.

PACKING LIST

Please check the following items that can be found in this package.

- ?? Digital Audio Player (on board flash embedded)
- ?? Earphones
- ?? USB cable
- ?? User' s Manual
- ?? Driver installation CD
- ?? Carrying bag
- ?? SM / MMC / SD card (optional)

WARNINGS

Under Copyright laws the user is liable to obtain the license, before playing or recording copyright protected music, except for **personal use**. That is, if you make **one recording only** for playing to yourself, or for personal use at home. **This applies to music files on Web pages too!**

The moment you give only one copy to someone else, you are distributing or duplicating the music and it is no longer for your personal use, you must obtain a license to do this first.

PRECAUTIONS

The supplier holds no liability for any claims if the product ceases to function correctly due to misuse, because it has been dropped, subjected to violent vibration, extremes of temperature or if any attempt has been made to open the case, apart from the battery cover, to replace batteries.

1. Normal vibration will not affect the operation of player. However, dropping or shocking may cause damage to the product.
2. The product is not designed for water-resistant usage. Drenching the product may cause damage.
3. Do not clean up the product with chemicals such as thinners, benzene and alcohol that may deface the surface.
4. Avoid placing the player in places of high humidity or close to a heat source.
5. Unintentional electrostatic discharge may shut down or damage the product. You may need to remove then replace the batteries to reset it.

CONTROLS & DISPLAY

A. Flash type /Flash type with FM

B. SD type/SD type with FM

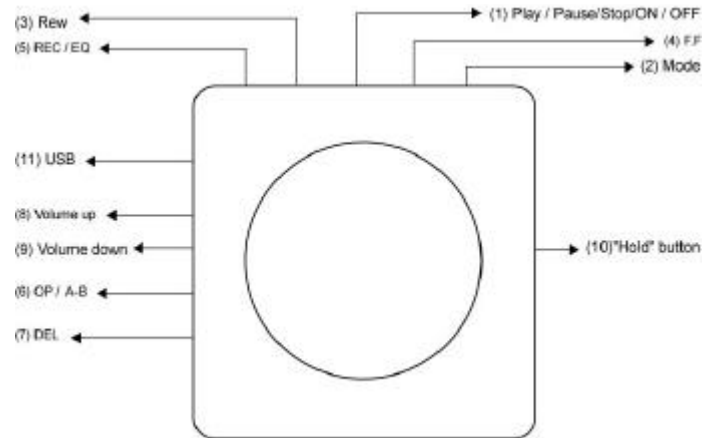
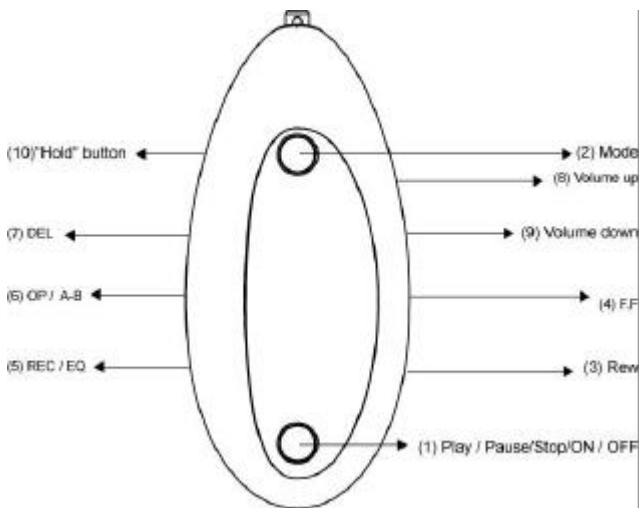

C. Smc type/ Smc type with FM

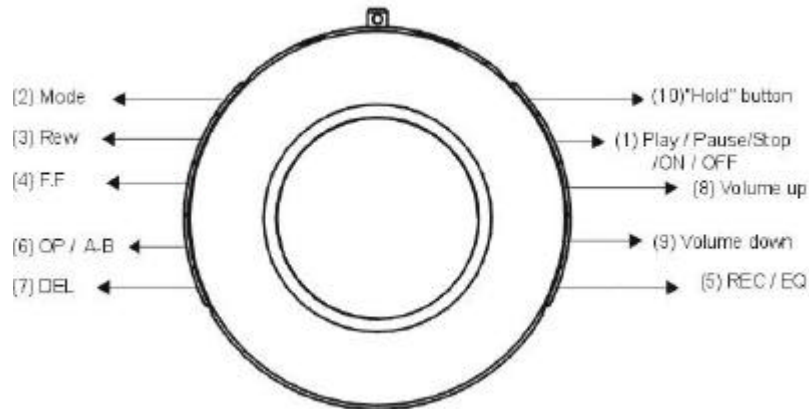

KEY DEFINITION

No	Key	Description
(1)	? ; /	1) Turn on player 2) Initiate Music playback 3) Pause while Music playback 4) Stop while Music playback 5) Turn off player
(2)	MODE	Switch between music and voice mode
(3)	? ? Rew	1) Press and hold to backward search 2) Press and release to previous songs
(4)	? ? FF	1) Press and hold to forward search 2) Press and release to next songs
(5)	REC / EQ	1) Record external voice in voice mode 2) Select equalizer in music mode
(6)	OP / A-B	1) Press to alter playback sequences in idle mode 2) Press to trigger A-B function in playback mode
(7)	DEL	Delete music or invoice files
(8)	VOL +	Volume up
(9)	VOL -	Volume down
(10)	HOLD	Slide switch to avoid unintentional touch

UNDERSTANDING THE LCD INFORMATION

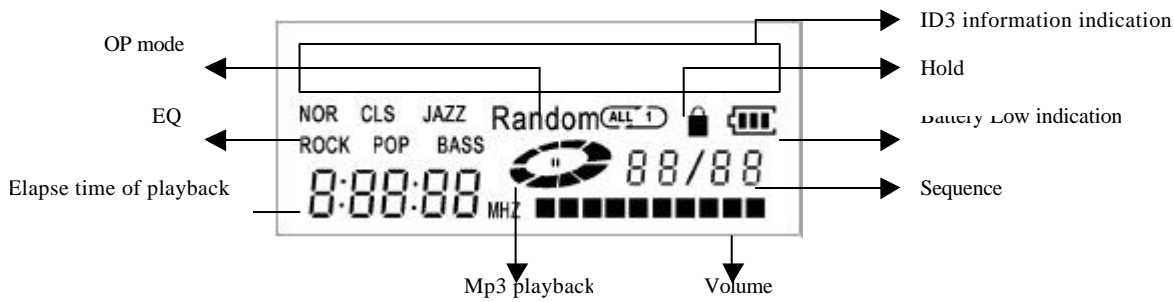

HOW TO LISTEN TO MUSIC

TO POWER ON

Press **?** **|** **/** button to power on the player.

If the inserted memory card has been plugged in properly, both data in the on board flash memory and memory card can be accessed. (*B, C)

While the player has been powered on and there are existent MP3 / WMA format files in on-board flash memory or memory card (*B, C), track number 001 and track title of the very first song will show up on the LCD screen. (If track title of the first song has not been specified, no characters will show up on the ID3 information section) Otherwise, track number 000 will show up on it.

TO POWER OFF

Press and hold **?** **|** **/** button over 2 seconds to turn it off. Note that if this player is idle for 50 seconds, it will turn itself off automatically.

PLAYING STORED FILES

While the player is not operating (idle), pressing **?** **|** **/** button will start playback operation.

STOPPING & PAUSING WHILE PLAYING

Press and hold **?** **|** **/** button within 2 seconds to stop playback.

Press **?** **|** **/** button to suspend playback operation.

Press **?** **|** **/** button again to resume playback.

FAST FORWARD

Press and hold **?** **?** (FF) button to trigger fast-forward searching while playing.

REWIND

Press and hold **?** **?** (Rew) button to trigger rewind searching while playing.

SELECTING FILES

Press **?** **?** (FF) or **?** **?** (Rew) buttons, and release within 1.5 seconds to select the next or previous music file in the on board flash memory or memory card.

OP

While the player is not operating (idle mode), press **OP** button to switch between the following playback sequences:

Symbol	Description
NO SIGNS	Sequential playback
	Repeating on-going song playback
	Repeating playing all songs in the on board flash memory and memory card
Shuffle	Randomly playing all songs in the on board flash memory and memory card once

Shuffle All	Randomly playing all songs in the on board flash memory and memory card continually
----------------	---

EQUALIZER

Press **REC/EQ** button to select the next equalizer modes for music playback. Selection cycle in the sequence:

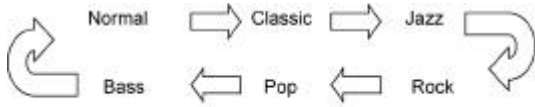

A B CLIPPING

Once the Player is in the process of playback, press **OP** button to trigger A – B clipping function and set the start point. Press it again to set the end point of A – B clipping and start playing the selected content. While the selected content has been clipped, press **OP** button to cancel A – B clipping and resume playback.

NOTE: You can only clip the content within single music file.

LANGUAGE

1. Press “**MODE**” button to switch between the modes and find the “**LAN**” mode.
2. Press ‘ ’ or ‘ ’ button to switch between the following playback sequences : **CHINESE-SIMP, CHINESE-TRAD, EUROPE, KOREAN, ENGLISH, JAPANESE .**
3. Select any language you want to use .
4. Press “**MODE**” to confirm your choice and return .

HOLD KEY

Slide the **Hold** switch to hold position to lock all the above buttons.

HOW TO RECORD / LISTEN TO DVR FILES

TO POWER ON

Press ? | / button to power on the player. Whether the player is idle or playing, press **MODE** button to switch into voice mode.

While there are existent wav format files in on-board flash memory, track number 001 and file name (VXXX. wav) will both show up on the LCD screen. Otherwise, track number 000 will show up on it.

TO POWER OFF

Press and hold ? | / button over 2 seconds to turn it off. Note that if this player is idle for 50 seconds, it will turn itself off automatically.

PLAYING STORED FILES

While the player is not operating (idle), pressing ? | / button will start playback operation.

STOPPING & PAUSING WHILE PLAYING

Press and hold ? | / button within 2 seconds to stop playback.

Press ? | / button to suspend playback operation.

Press ? | / button again to resume playback.

FAST FORWARD

Press and hold ? ? (FF) button to trigger fast-forward searching while playing.

REWIND



Press and hold ? ? (Rew) button to trigger rewind searching while playing.

SELECTING FILES

Press ? ? (FF) or ? ? (Rew) buttons, and release within 1.5 seconds to select the next or previous voice file in the on board flash memory.

OP

While the player is not operating (idle), press **OP** button to switch between the following playback sequences:

Symbol	Description
NO SIGNS	Sequential playback
	Repeating on-going song playback
 All	Repeating playing all songs in the on board flash and memory card, which has been inserted
Shuffle	Randomly playing all songs in the on board flash and memory card once
Shuffle  All	Randomly playing all songs in the on board flash and memory card continually

A B CLIPPING

Once the Player is in the process of playback, press **OP** button to trigger A – B clipping function and set the start point, press it again to set the end point of A – B clipping and start playing the selected content. While the selected content has been clipped, press OP button to cancel A – B clipping and resume playback.

NOTE: You can only clip the content within single voice file.

RECORD

While the player has been changed to voice mode, press REC / EQ button to trigger live recording. Press it again to terminate recording.

HOLD KEY

Slide the **Hold** switch to hold position to lock all the above buttons.

HOW TO USE FM FUNCTION

1. KEY DEFINITION FOR FM FUNCTION

No	Key	Description
(1)	? ↓ /	1) Switch among the preset channels 2) Set the selected channel 3) Press for 3 seconds to turn on/off the player
(2)	MODE	Switch among music, voice and FM mode
(3)	? ? Rew	1) Press and hold for two seconds to previous station 2) Press and release to adjust frequency by 50khz.
(4)	? ? FF	1) Press and hold for two seconds to next station. 2) Press and release to adjust frequency by 50khz.
(5)	REC / EQ	1) Record FM voice in FM mode
(6)	OP / A-B	1) Press to start presetting channel.
(7)	VOL +	Volume up
(8)	VOL -	Volume down
(9)	HOLD	Slide switch to avoid unintentional touch

2. HOW TO LISTEN TO FM RADIO

If you want to enable the FM radio function, just need to press the “MODE” button to switch to FM mode. Then you will see the FM display show up.

2.1 Preset channel

2.1.1 Select a desired channel

2.1.2 Press “OP/A-B” button to start presetting

2.1.3 While the “1 Channel Save” sparkling, press FF or REW button to choose the appointed channel and then press the “PLAY” button to finish the presetting.

- 2.1.4 If you want to enter the preset channel, press “PLAY” button to listen and enter next preset channel.
- 2.1.5 If you want to leave the preset channel, press FF or REW button to returning to FM MODE

Note: you just can set up to 20 channels.

2.2 FM record

- 2.2.1 Select a desired channel
- 2.2.2 Press “REC” button to start FM recording.
Press “REC” button again to stop recording.

HOW TO USE ENCODE FUNCTION

1. KEY DEFINITION FOR ENCODE FUNCTION

No	Key	Description
(1)	? /	1) Press to finish erasing. 2) Press to finish formatting. 3) Press for 3 seconds to turn on/off the player
(2)	MODE	Switch among line-in, voice, FM, menu and music mode
(3)	? ? Rew	Press and hold for two seconds to previous station
(4)	? ? FF	Press and hold for two seconds to next station.
(5)	REC / EQ	1)Record sound source in LINE-IN mode 2)Five sound equalizers(NOR/BASS/JAZZ/POP/ROCK)
(6)	VOL +	Volume up
(7)	VOL -	Volume down
(8)	HOLD	Slide switch to avoid unintentional touch

2. HOW TO RECORD / LISTEN TO ENCODE FILES

If you want to enable the encode function, just need to press the “MODE” button to switch to LINE-IN mode. Then you will see the “LINE-001” display show up.

2.1 Encode

- 2.1.1 Use the audio cable and connect the line-out end of the cable to the sound source.
- 2.1.2 Connect the line-in end of the cable to the MP3 player.
- 2.1.3 While the “sound source” sparkling, press “REC” button to start encoding.
- 2.1.4 Press “REC” button again to stop recording.

2.2 Erase

- 2.2.1 Press “MODE” button to start erasing.
- 2.2.2 Press “DEL” button under the “LINE-IN MODE”
- 2.2.3 Display the window “ERASE YES/NO” and press ? | / to finish erasing.

2.3 Format

- 2.3.1 Press “MODE” button to start erasing.
- 2.3.2 Press “DEL” button twice under the “LINE-IN MODE”
- 2.3.3 Display the window “FORMAT YES/NO” and press ? | / to finish formatting.

Note: while you execute the format function, the songs in encode files and mp3 files are all disappeared.

INSTALLING DRIVER SOFTWARE

MINIMUM SYSTEM REQUIREMENTS

Windows 98SE / ME / 2000 / XP.

Pentium 200 MHz or above.

Disk Drive 16MB free hard disk space (to download and upload files from the player).

32MB system memory

USB port (A-Type).

NOTE:

This specification is for the download driver software supplied with this player only. An increased PC specification is likely to be required for application software for music file creation.

INSTALLING THE DRIVER SOFTWARE

DON'T connect the USB cable from your computer to your MP3 player **BEFORE** installing the driver.

1. Put the installation CD into CD-ROM Drive and the "Install For Audio Devices" dialog box appears as below.

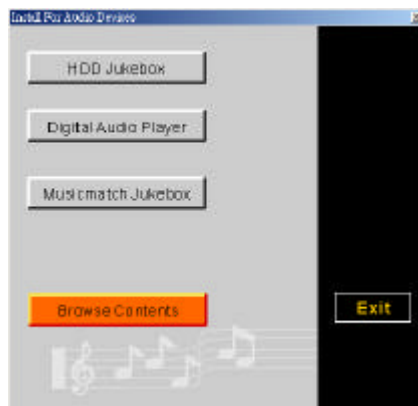

2. Press "HDD Jukebox" or "Digital Audio Player" to install the AP or/and the DRIVER.

3. If you choose "Digital Audio Player", the dialog box appears as below.

You can press the button by the function of your player. (The function notes on the side of package.)

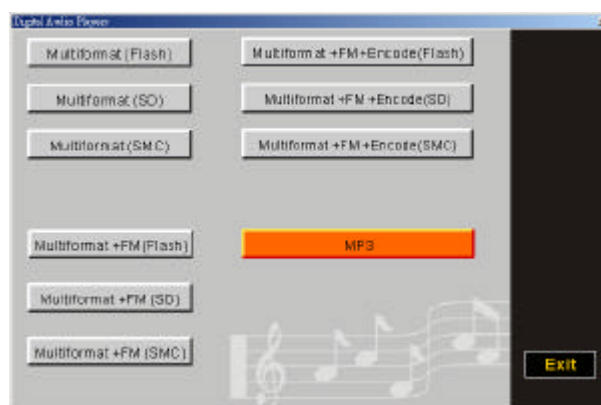

4. Follow the instructions to continue installing.
5. After Windows is done installing the drivers, press the "Finish" button to finish the installation process.
6. Plug the USB cable from your computer to your MP3 player.
7. The computer will detect the player as a new device.

Note: If the computer doesn't detect the player as a new device, **Please restart your computer.**

USE AS PC DRIVES

FORMATTING ON BOARD FLASH MEMORY OR MEMORY CARD FOR FIRST USE

You may use the player for the first time or probably buy a new memory card (*B, C), or even if a previously used memory card (*B, C) becomes corrupted you will need to format it. Before you may format it you must first have installed the USB driver as described in the previous section.

1. Make sure the unit is turned OFF when you insert and remove the SD/MMC card.
2. With the memory card installed in the player connect the Player to your PC' s or (Notebook' s) USB port with the USB cable supplied. (*B, C)
3. Click Start \searrow Programs \searrow Digital Audio Player \searrow Format Audio Player
4. Click on the **My Computer** icon, you will find two new removable drives such as “ E “ and “ F “drives. (*B, C) or single drive.
5. Right click the drive icon with the mouse and select **Format** from the menu displayed.
6. Choose the target drive to format. SD/MMC cards of 32, 64 MB will format under FAT 12; if the SD/MMC card is 128 or more, then the card will format under FAT 16.

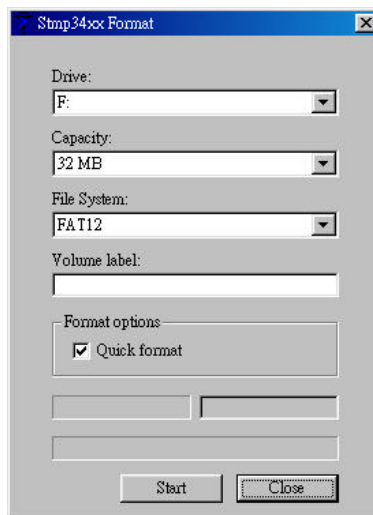

7. Then optionally enter a disk label to identify the card as required, and click **START** to format the card.
8. If the memory card has not been inserted into the card slot, operation system will prompt error message while you have clicked the later drive. (*B, C)

NOTE: All of the old data in the memory card or on board flash memory will be permanently lost.

GETTING FILES ONTO THE PLAYER

This player adopts the Windows **FAT 12/ 16** file system, it is therefore easy to copy files to and from your player, once you have installed the driver software as described in the previous section.

To copy file to or from the player using the PC, you need to:

1. Insert the memory card into the player. (*B, C)
2. Connect the player to the PC (or Notebook) with the USB cable supplied. Two new removable drives such as “ E “and “ F “

“(B, C) or single one (A) will appear in the **My Computer** window.

3. MP3 / MP3PRO / WMA files can then be copied to or from this drive as with any other type of disc drive.

MESSAGE WHILE CONNECTION

The “PC LINK” characters will show up at the ID3 Information section to indicate the player has been connected to the USB port. While data transferring is on the go, “WRITING” or “READING” characters will show up at the ID3 information section. Do not disconnect the player from PC at this moment.

NOTES:

- ?? **The removable drive provided by this player can be used for storage of files with file format other than MP3 / WMA.**
- ?? **When a memory card or on board flash memory with no MP3 / WMA files stored in it is, pressing the ? ! / button will have no effect.**
- ?? **Any abnormal disconnection between PC and player may cause the computer to halt while transmitting data. This may cause the data in the on the board flash or memory card to be written in error. You may need to re-format either before you can continue to use them.**
- ?? **Once the transfer of files has been started, you may press the Cancel button on the dialogue window to terminate the transferring process. Because it takes some time for PC to remove the data from the register buffer, the dialogue box may soon disappear on the window but the data exchange between the host and device is still in the process. Before you disconnect the Player from the PC, be sure to check the LCD screen of the Player to judge whether the above process has been terminated. (Tip: “READING ” or “WRITING” characters extinguish and “PC LINK” characters revive)**
- ?? **Once the payer has been connected to PC (or Notebook) via USB, do not remove the memory card unless the player has been disconnected from the USB port. If not, you may cause data damaged.**

PRODUCT SPECIFICATIONS

Power Sources	1.5 Volts, one AAA-size battery via USB connection	
LCD	STN LCD screen (32.4*13 mm, 78 X 8 dots)	
Storage	A	On board flash
	B	On board flash and extended MMC / SD card
	C	On board flash and extended SM card
Size	A	77 X 33 X 24 mm
	B	57 X 59 X 19 mm
	C	72 X 72 X 22 mm
Weight (Without	A	40g
	B	50g
	C	52g
PC Connection	USB V1.1	
File System	FAT 12 (16 ~ 64MB) FAT 16 (128 or above)	
S/N Ratio	90dB	
Earphone O/P	50mW	
Frequency	20Hz~20KHz	

Response	
----------	--